

# MAGRON

# FERROFLUID

MAGRON

Catalog No. 20240328

---

## For Gas & Dust sealing

- Feedthrough component
- Vacuum Seal component

# Contents

---

<b>01</b>	<b>Ferrofluid for Gas&amp;Dust Sealing Specification</b> Corrosive(active)gas, Non-Corrosive gas(inert), Grease Type	3p
<b>02</b>	<b>TGA/DTA Grade</b>	5p
<b>03</b>	<b>Ferrofluid</b> What is Ferrofluid Seal? / Features & Advantages / Feedthrough Parts Diagram	7p
<b>04</b>	<b>Application</b> Semiconductor/Display/Power&Energy/Manufacturing area/Nuclear power&Military&Nuclear Fusion	8p

# Gas&Dust Sealing Specification

## ● For Corrosive gas

Carrier fluid: Perfluore Polyether [PFPE]

Item	Saturation Magnetization	Viscosity	Vapor Pressure		Torr· L/s Helium gas leak	1 wt/% loss Temp. (TGA)	Pour point	Density
			Pa at 20°C	Torr mmHg. at 20°C				
Model	Gauss	mPa.sec (cP) at 27°C	Pa at 20°C	Torr mmHg. at 20°C	Less than 1E-11	°C	°C	g/cm <sup>3</sup>
MFF-KD3847	380	4700	1E-12	7.5E-15	Ok	260	<-30	2.17
MFF-KD4350	430	5,000	1E-12	7.5E-15	Ok	260	<-30	2.17
MFF-KR4549	450	4,900	1E-12	7.5E-15	Ok	230	<-30	2.2
MFF-R6085	600	8,500	1E-14	1E-16	Ok	140	<-30	2.25
MFF-R5050	500	5,000	1E-12	7.5E-15	Ok	140	<-30	2.2
MFF-R4020	400	2,000	1E-12	7.5E-15	Ok	140	<-30	2.14

\*1 wt/% loss Temp. (TGA): The temperature at which 1% of the weight is reduced by evaporation or vaporization during heating. (Measurement conditions: Heat up 10°C per minute with a TGA measuring instrument)

\*Vapor pressure is the value of Pure base oil used.

\*Actual operating temperature varies depending on conditions such as temperature applied to the ferrofluid, RPM, shaft diameter, and operating time.

Please determine the operating temperature considering the above conditions.

\*Besides the above products, we can make custom orders

## ● Advantages in Specific condition for each model

### MFF Series

This series has excellent chemical resistance and radiation resistance.

### MFF-KD Series

**World's Top Heat-Resistant Model for corrosive gas**

# Gas&Dust Sealing Specification

## ● For Non-Corrosive gas

Carrier fluid: MFS series - Silicon, MFH series - Hydrocarbon

Item	Saturation Magnetization	Viscosity	Vapor Pressure		Torr- L/s Helium gas leak	1 wt/% loss Temp. (TGA)	Pour point	Density
			Pa at 20°C	Torr mmHg. at 20°C				
Model	Gauss	mPa.sec (cP) at 27°C	Pa at 20°C	Torr mmHg. at 20°C	Less than 1E-11	°C	°C	g/cm <sup>3</sup>
MFS-7390	730	9,000	1E-9	7.5E-12	Ok	200	<-40	1.50
MFS-6022 (MFS-630)	600	2,200	1E-7	7.5E-10	Ok	200	<-40	1.39
MFS-5009 (MFS-513)	500	900	1E-7	7.5E-10	Ok	200	<-40	1.31
MFS-4005 (MFS-407)	400	500	1E-7	7.5E-10	Ok	200	<-40	1.21
MFH-7730	770	3,000	1E-9	7.5E-12	Ok	170	<-40	1.52
MFH-6206	620	650	1E-7	7.5E-10	Ok	170	<-40	1.39
MFH-5002 (MFH-503)	500	210	1E-7	7.5E-10	Ok	170	<-40	1.30
MFH-4401	440	150	1E-7	7.5E-10	Ok	170	<-40	1.22

\*1 wt/% loss Temp. (TGA): The temperature at which 1% of the weight is reduced by evaporation or vaporization during heating. (Measurement conditions: Heat up 10°C per minute with a TGA measuring instrument)

\*Vapor pressure is the value of Pure base oil used.

\*Actual operating temperature varies depending on conditions such as temperature applied to the ferrofluid, RPM, shaft diameter, and operating time.

Please determine the operating temperature considering the above conditions.

\*Besides the above products, we can make custom orders

## ● Advantages in Specific condition for each model

### MFS-Series

**This series has the world's best heat resistance for non-corrosive gas.**

### MFS-4005

One of the most used models.

### MFH-5002

A model with very little rotational start torque even when started after being left unattended for a long time.

## ● Grease type

For Non-Corrosive gas&dust sealing + lubrication

MFG-50	500		1E-10	7.5E-13	Ok	140	>400	-90	1.4
--------	-----	--	-------	---------	----	-----	------	-----	-----

\*It is not liquid, but has the same shape as grease.

# TGA&DTA Grade

## TGA

### : Thermo Gravimetric Analysis

It measures the weight change of the sample according to temperature while performing simultaneous thermal analysis.

In other words, you can know the amount of vaporization, evaporation, and oxidation according to the temperature.

You can estimate the temperature available at high temperatures.

## DTA

### : Differential Thermal Analysis

It measures thermal decomposition temperature by endothermic heat and heat.

You can see the temperature at which phase change, reduction, decomposition, and oxidation occur.

## MFF-KD Series

(Rising temperature per minute : 10°C)

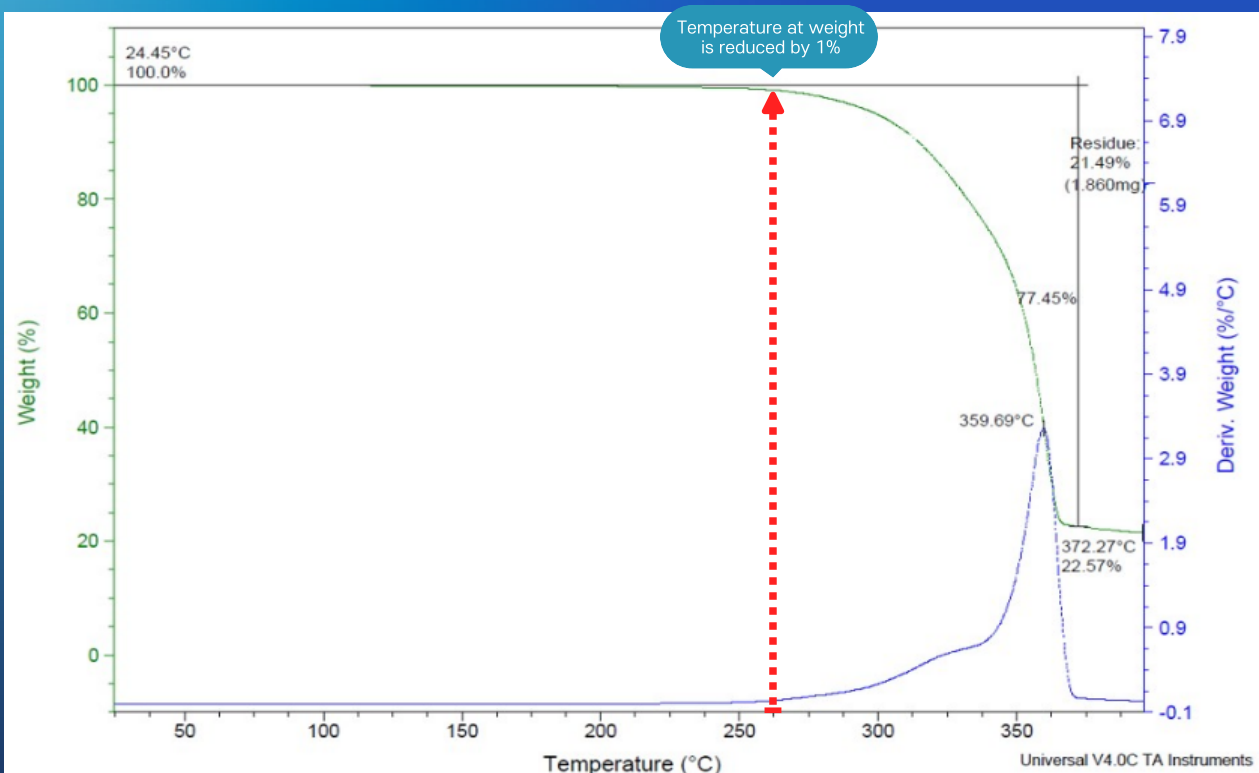

## MFF-KR Series

(Rising temperature per minute : 10°C)

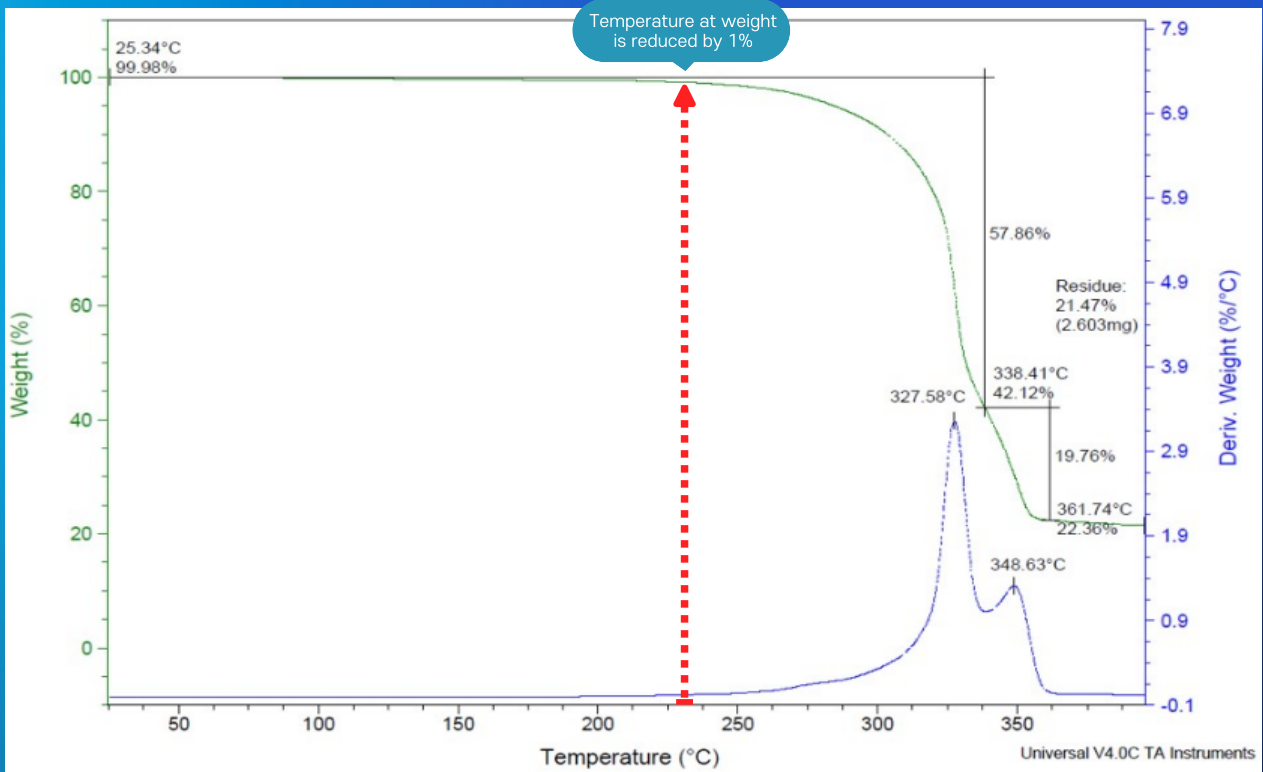

## MFF-R Series

(Rising temperature per minute : 10°C)

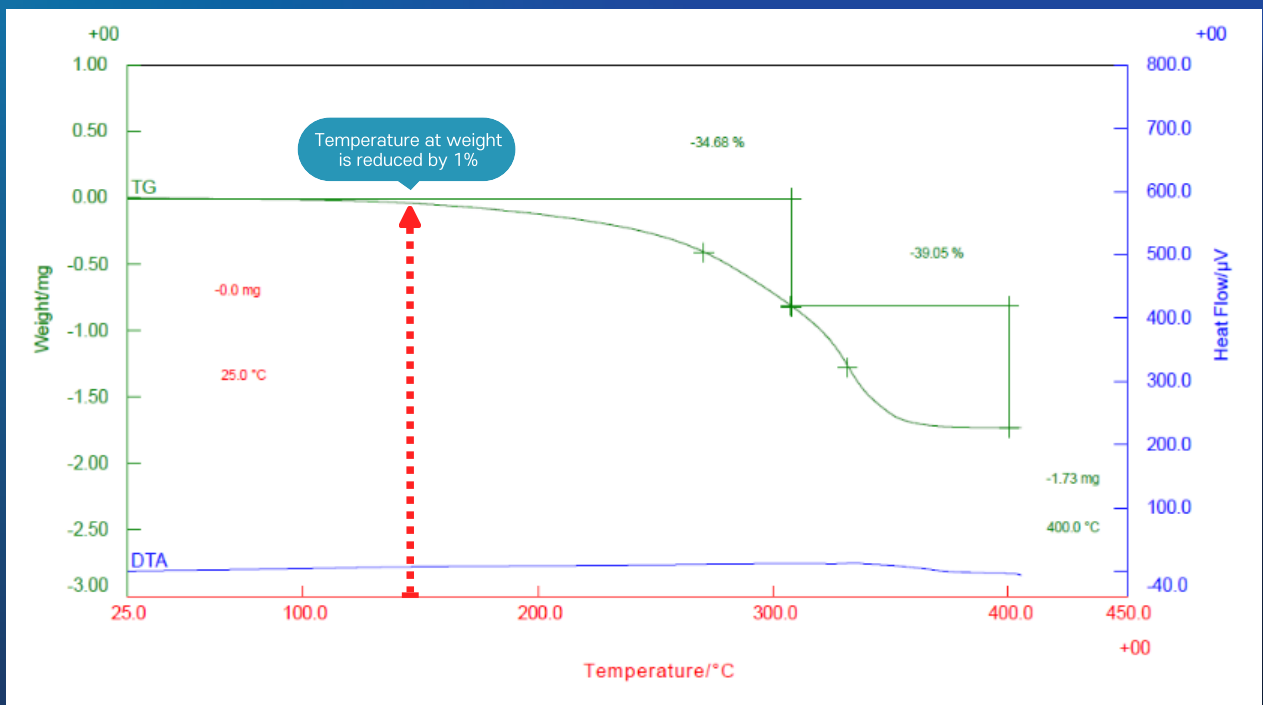

## MFS Series

(Rising temperature per minute : 10°C)

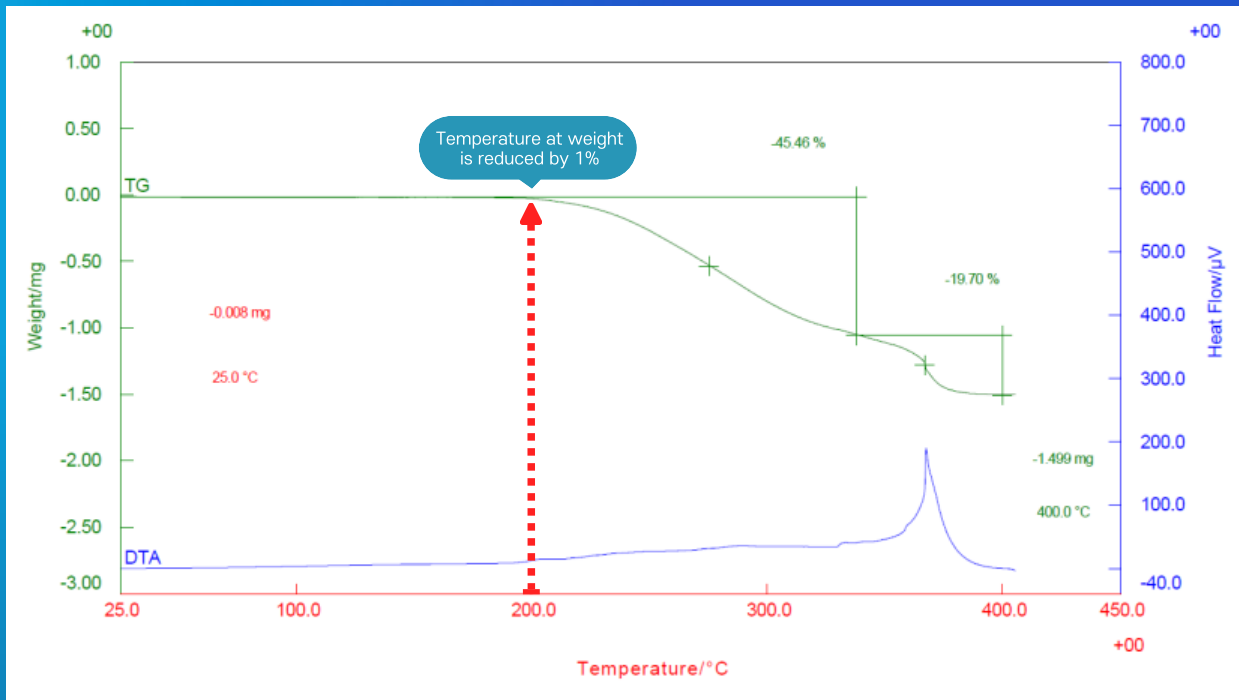

## MFH Series

(Rising temperature per minute : 10°C)

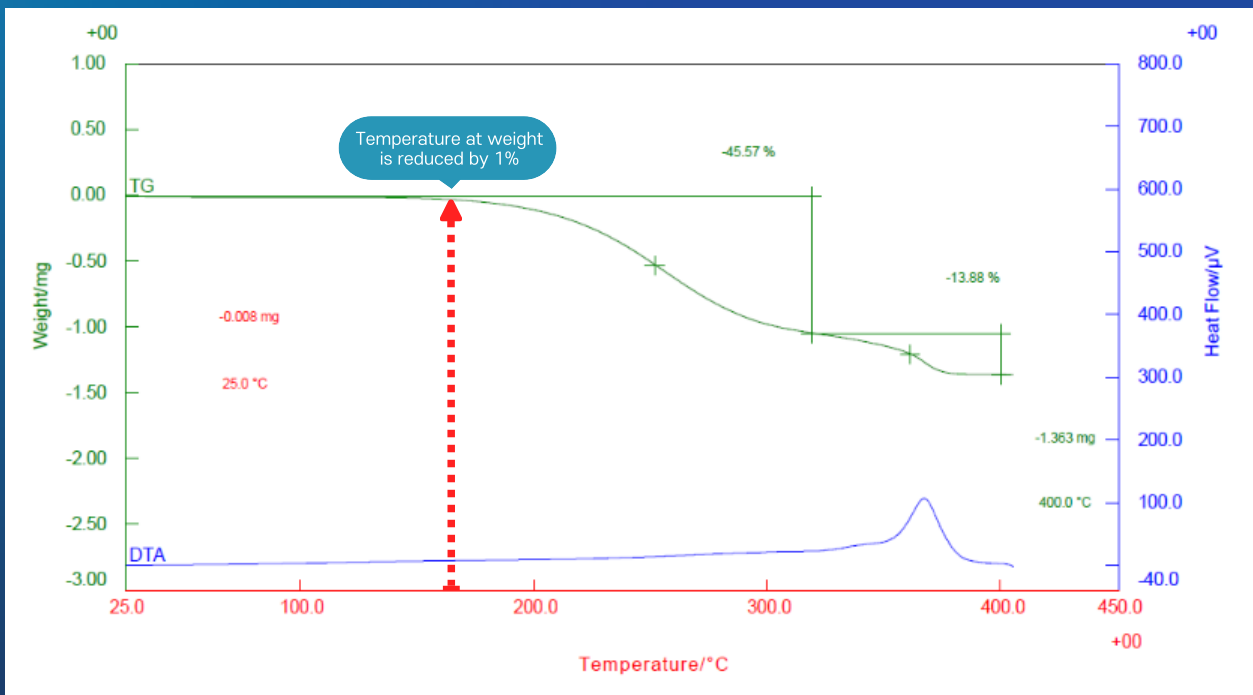



# Ferrofluid Seal

## What is Ferrofluid Seal?

### Ferrofluid Seal:

Ferrofluid seal is a component used to shield gases and dust in high vacuum. It creates a magnetic field with a magnet and a pole piece in the gap between the magnet and the axis of rotation. When magnetic fluid is injected into this gap, it forms the shape of a liquid O-ring and is a non-contact seal that acts as sealing. Typically, feedthrough uses several ferrofluid rings. Each ring has a pressure capacity that remains vacuumed, and the total pressure capacity is approximately equal to the sum of the pressure capacities of each ring. No friction increases facility, durability and blocks harmful gases and dust in ultra-high vacuum conditions.

## Features & Advantages



## Feedthrough Parts Diagram

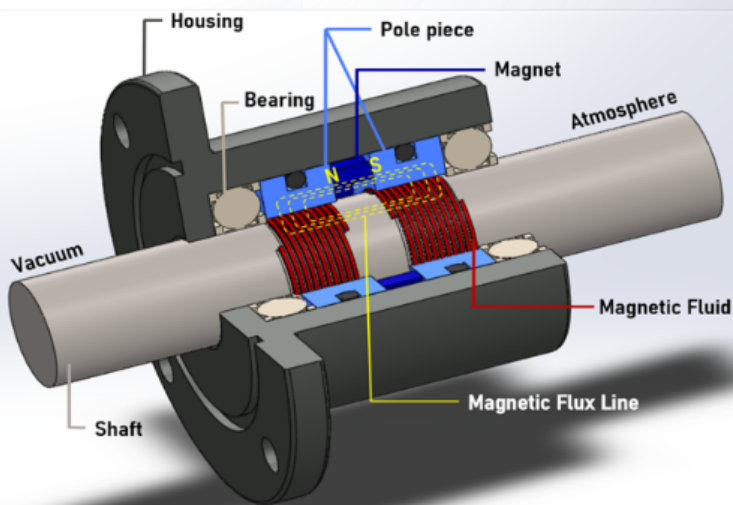

● ferrofluid

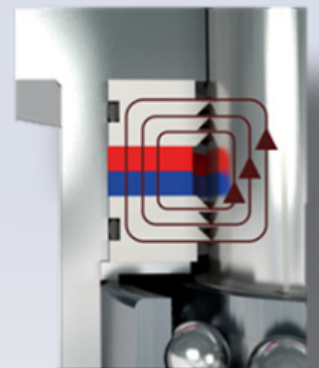



# Application

## Ferrofluid & Feedthrough application

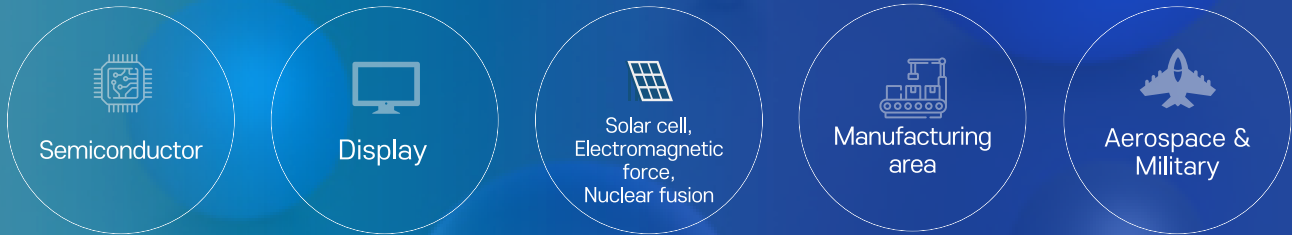

- CVD
- Sputtering system
- Ion implanter
- Etching system
- Vacuum transfer robot
- Arc discharge
- Ion beam system
- Film panel
- LED, OLED manufacturing equipment
- Anode x-ray generator
- Vacuum chuck
- Solar panel
- New energy battery
- Single crystal growth
- Vacuum furnace
- Stirring assembly

### Feedthrough

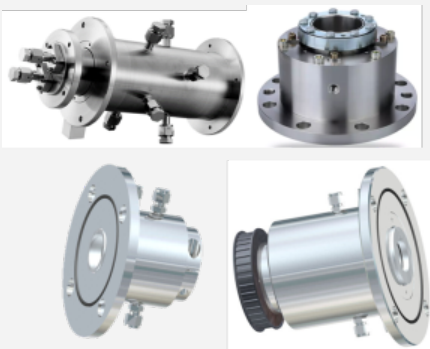

### CVD



### Ion implanter



Single crystal growth

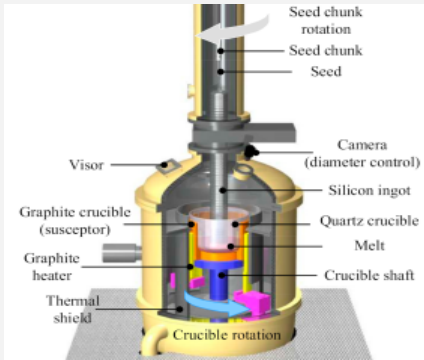

Sputtering systems



Etching system

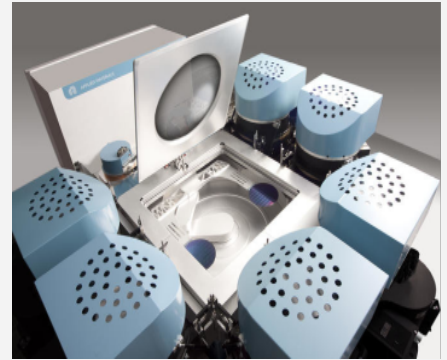

Vacuum transfer robot



Vacuum chuck

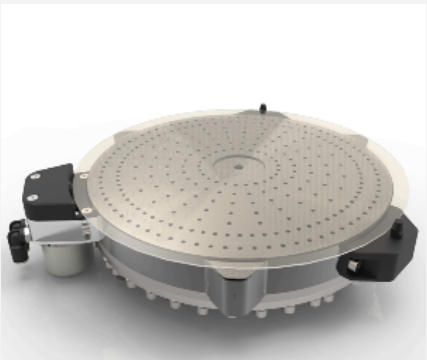

Ion beam system

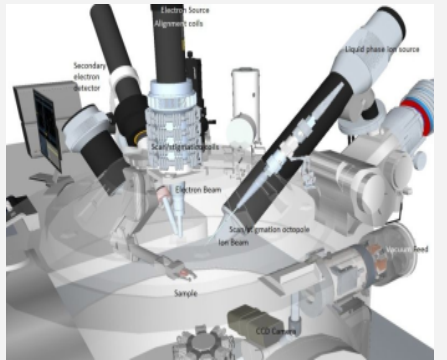

LED, OLED Film panel

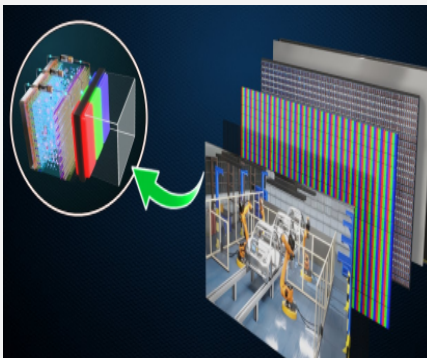

Anode x-ray generator

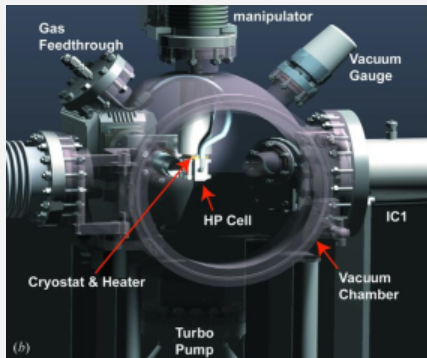

Solar panel



New energy battery

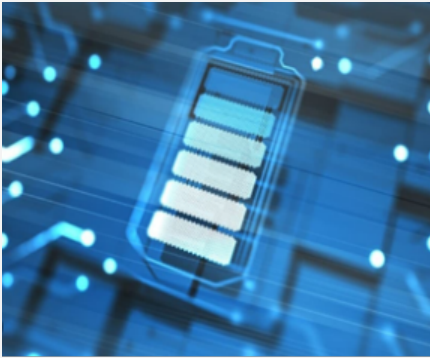

Nuclear power

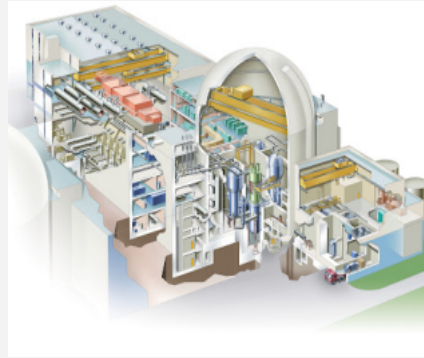

Nuclear fusion



Medical equipment



Aerospace

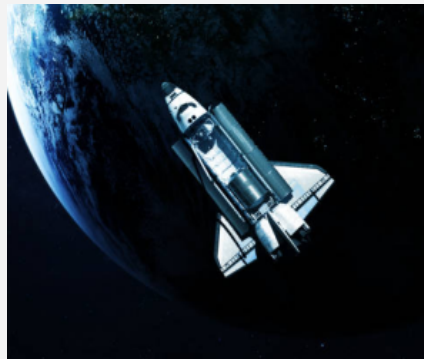

Military



**MAGRON**

**You can make an order  
with the specifications you want**

We constantly develop and release new products.

**Company information**



Address	#403 - 3 dong, Gyeonggi Technopark, 705 Haean-ro, Sangnok-gu, Ansan-Si, Gyeonggi-do, Republic of South Korea Post code : 15588	
Contact	TEL)+82 31-500-4632	
Mail address	magron@magron.co.kr	FAX)031-500-4631
Website	(KO) www.magron.co.kr	(EN) www.ferrozone.co.kr